

The ASML logo is rendered in a bold, dark blue, sans-serif font. The background of the slide features a light blue gradient with abstract, flowing white and light blue lines that create a sense of motion and depth.

Mission Possible  
Accounts Payable State of the Art Process

Albert Buijze

December 2018

# Agenda

- Introduction ASML
- Principles
- Current Process
- Why, How, What
- Digital World: Simplify, Transpose. Accelerate
- Lessons learned



# New devices, new applications



Wearable sensors  
(Holst Centre)



Imaging drone to monitor  
crop growth and yield (imec)

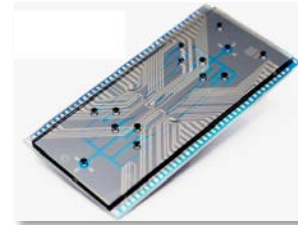

Cell sorter to detect  
metastization (imec)



Textile integrated  
health patch



Simband with health  
monitoring (Samsung)

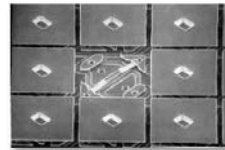

Micro mirrors for  
beamers (TI)

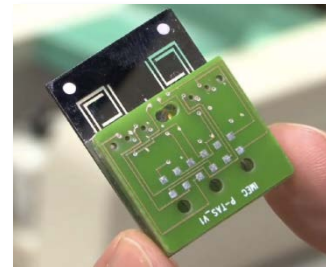

On-Chip DNA amplification and  
detection (imec/Panasonic)

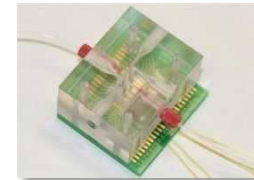

Lab on a Chip (LOC) for  
counting red blood cells

# ASML makes the machines for making those chips



- Lithography is the critical tool for producing chips
- All of the world's top chip makers are our customers
- 2017 sales: €9.1 bln
- More than 20,000 employees (FTE) worldwide

# Virtual Close

## More Than Technology

The virtual close is not just a matter of rolling out new **technology**. It requires a sustained, companywide effort to redesign our **processes**

## World Class Finance

# How to accelerate business growth

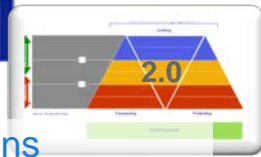
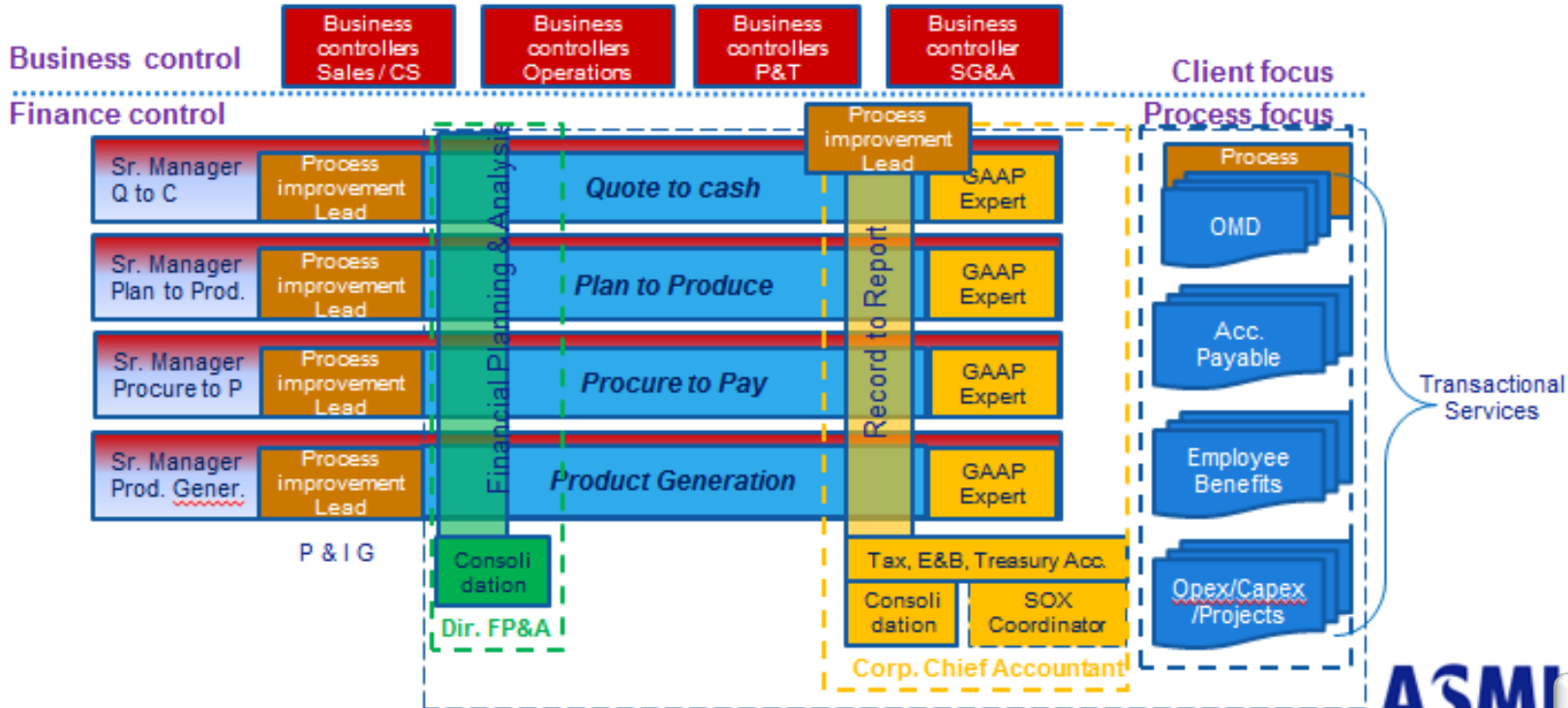

# Scope

- Assignment : AP from Score Keeper to Business Partner
  - Transparent AP Process, Stable Controlled
  - Low Cost and Sustainable
- Annual Spend 2017
  - 6.8 billion in value
  - 525.000 invoices
  - 5.500 active suppliers World Wide



# Validating Electronic Invoices on the Network

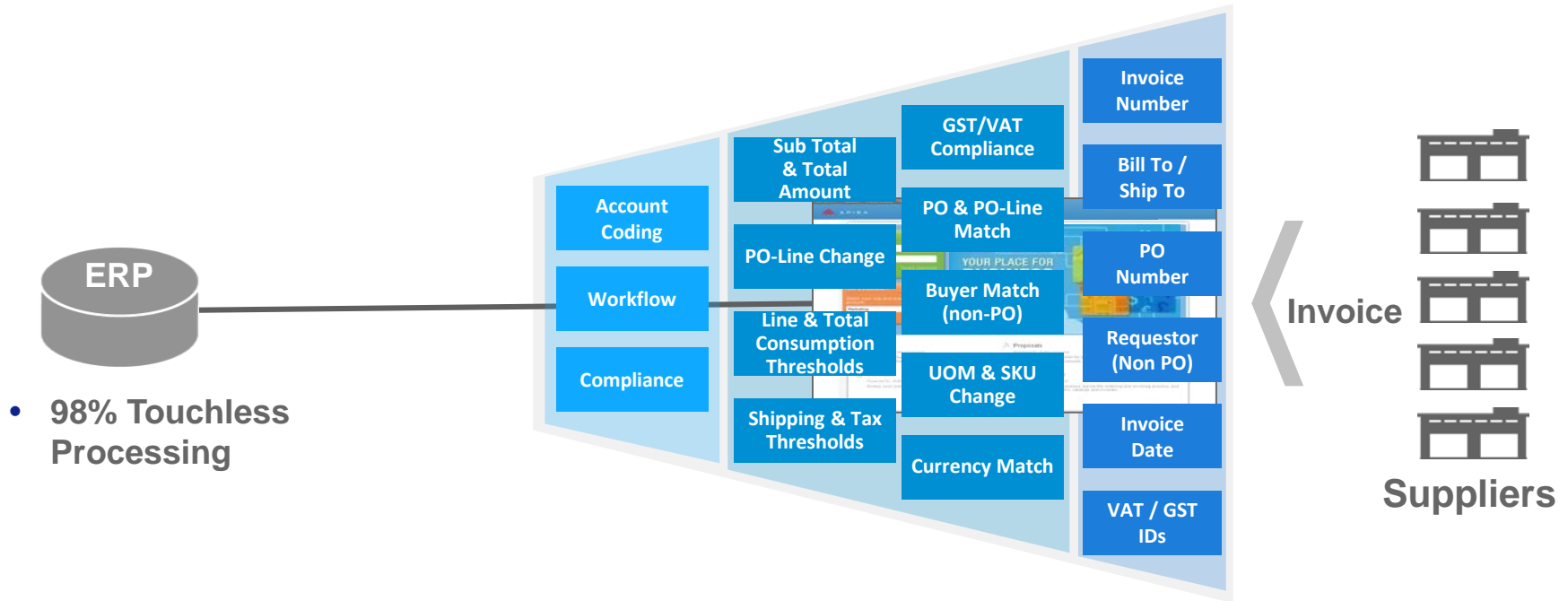

# ASML Accounts Payable

prepare for the **Digital-First World**

revolutions in technology, societal engagement, and enterprise operations will converge to change the way we all do business by the end of this decade

**Simplify** processes, **Transform** platforms, and **Accelerate** information delivery



**SIMPLIFY. TRANSFORM. ACCELERATE.**

# Current Process

## Accounts Payable is Posting Invoices

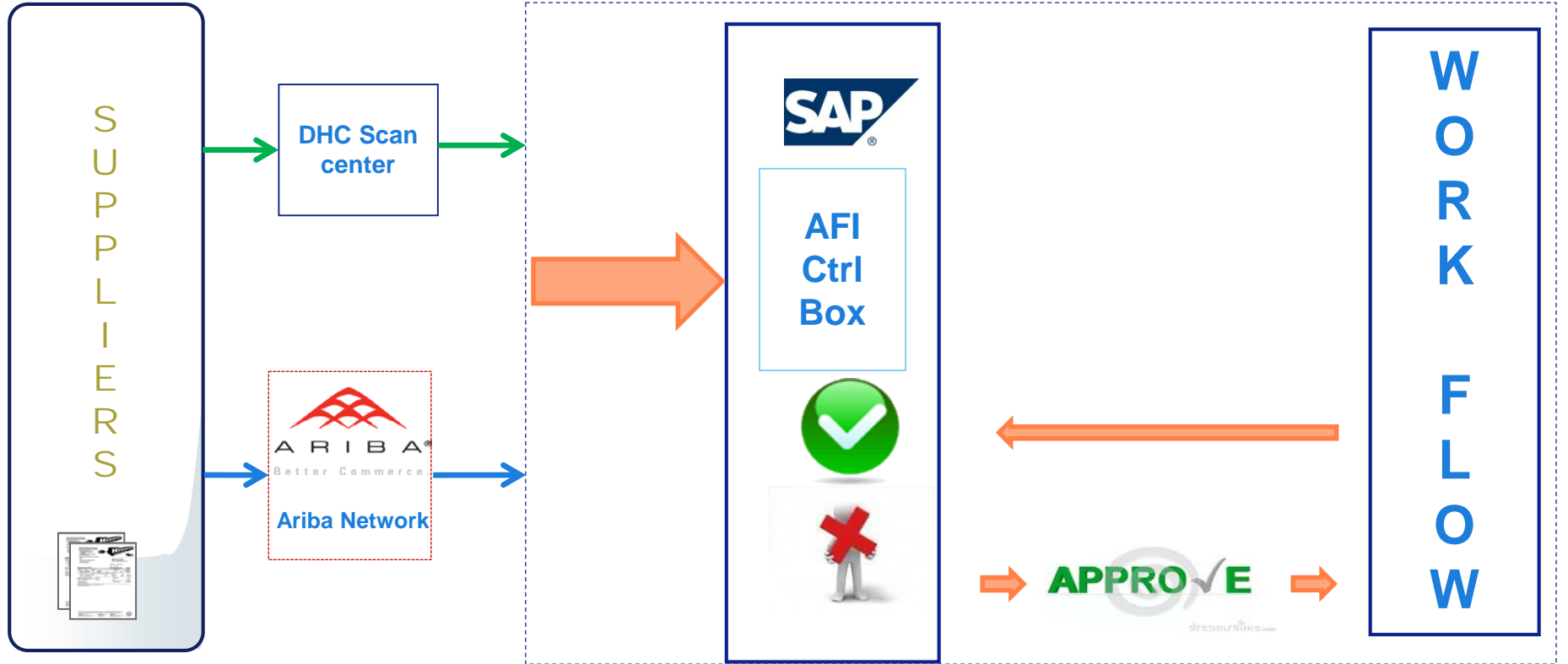

## Facts & Figures 2012 & 2018

- Auto posting rate of invoices went up from 40 to 85%
  - Total FTE reduction since 2010 is 20 till now, process and automation improvements
- 50% vendors enabled (invoice volume) on Ariba Network in two years
  - More PO's, Better Spend Control. No maverick buying
  - Throughput time reduction from 22 days to 7 days on average. Happy Flow was 10 minutes.
- Processing cost reduction from 30 euro to 3 euro per invoice

# ASML Accounts Payable

**Simplify** processes, **Transform** platforms, and **Accelerate** information delivery



**SIMPLIFY. TRANSFORM. ACCELERATE.**

# Simplify

- **Understand P2P Chain**
- **Respect the stakeholders in P2P process**
- **Use Buckets**
  - Split Spend in digestible parts
  - Create Clear Processes per bucket
  - Automate
- **Posting Invoices is easier through clear process and instructions (students instead of Flex)**
- **Vendor Master Data Management through MDG, (later combined with Ariba Network)**

# Procurement to Pay Chain

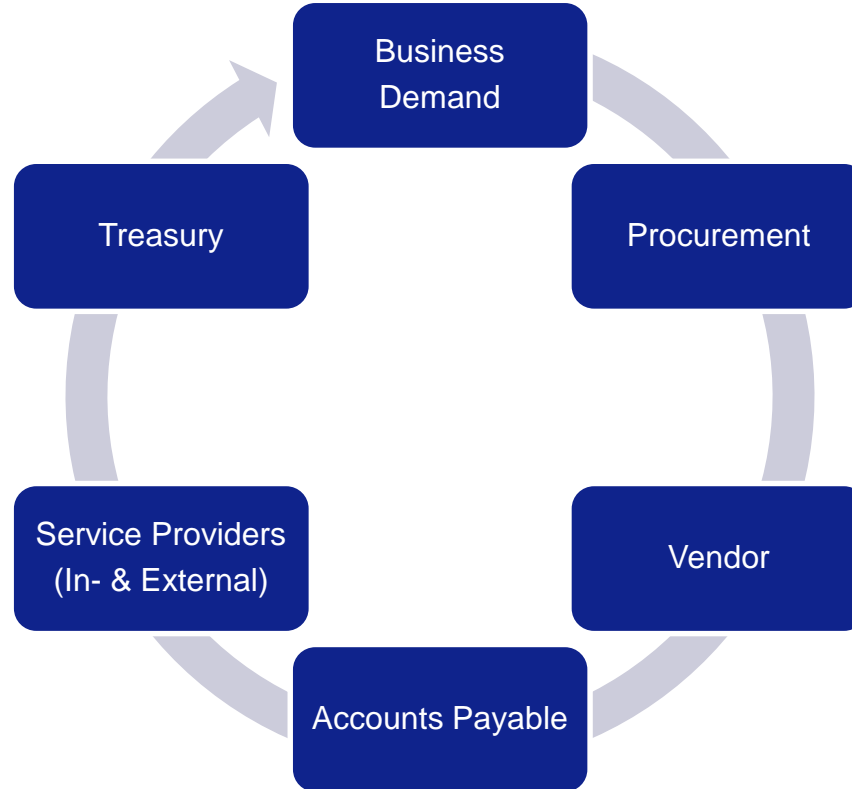

# Transform

- From Manual Posting of received paper invoices to
  - AFI Tool with logic and auto posting
  - Manual posting is boring and is not stable
- Paper invoices to PDF to scan center
- Ariba Network for e-invoicing, plus rules
- Students, incorrect posting rate did not change
  - More Flexibility
- Vendor Master Data Management through Ariba Network in MDG, SAP



## One Source of Truth (less IT, interfaces)

- AFI software
  - All invoice related events, from invoice date to payment date, per invoice are registered in AFI
  - AFI is basis for reporting. Combined with BW and Spotfire
  - This way issues can be monitored and improved
- Software Development by ASML AP and AFI and Ariba
- SAP, BW, Spotfire, daily automated reporting

# Accelerate

- Ariba Network, e-collaboration
  - Prohibit incorrect invoices entering SAP
- Fieldglass, better Flex Process
  - Easy hiring, quality, stable process, self billing
- Transparix, Freight solution, autoposting
- EasyBuy development
  - Contract buying and PO's
  - Rent contract PO's
- Less depending on IT services
- SAP, HANA, Spotfire, on-line automated reporting

# Current Process Ariba – AFI – SAP PO- Invoice Integration

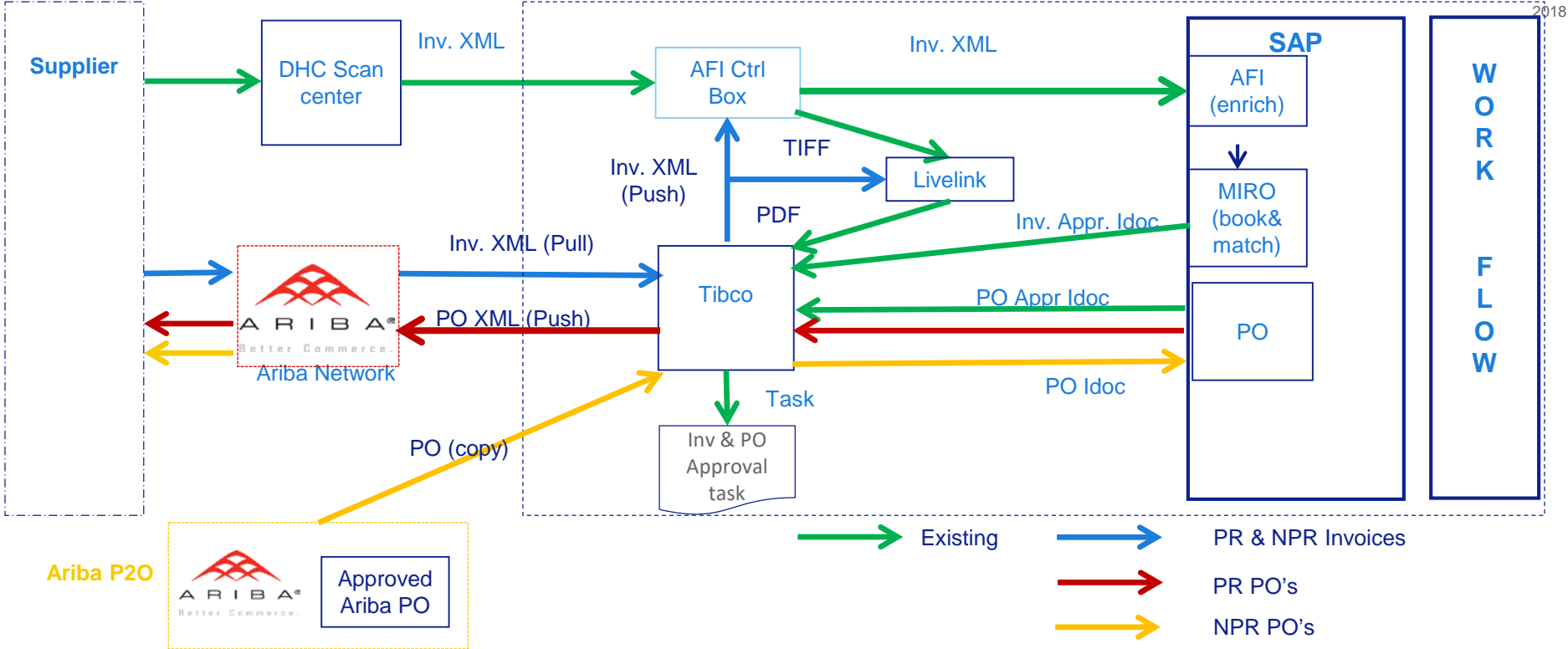

# To Be Process Ariba – SAP

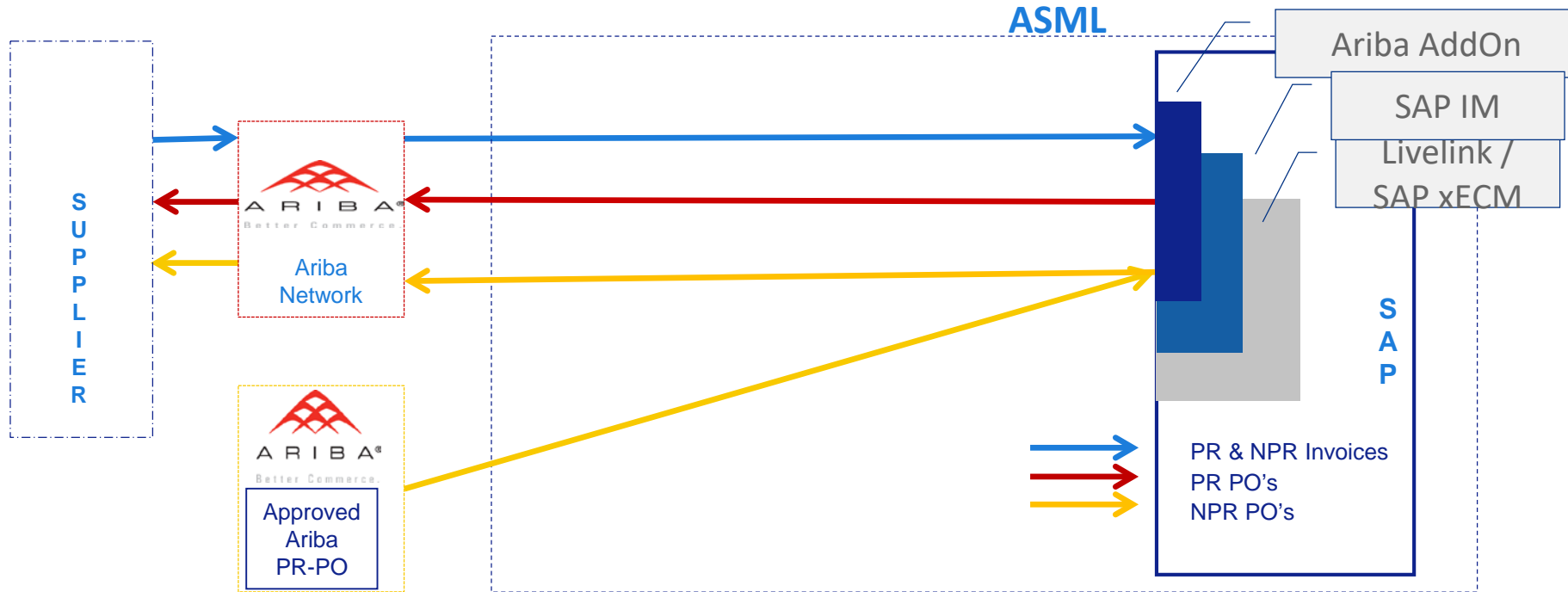

# Lessons Learned over 10 years

- You can only excel if you understand and work with the entire chain, in this case the P2P chain, P2P Process
- Pay Lots of Attention to Details
- Never Trust your External IT service providers
- Always ask for POC (Proof of Concept)
- Be aware of the IT “JWGWJBS” syndrome
- Internal awareness, need for change
- Vendor Awareness
- Software Development by ASML AP, AFI and Ariba
- Involve Internal Control from Day 1

